

# DVT 3.100

**SERVICE**

**BECKER**  
Qingou - PR CHINA  
www.becker-international.com

year

No. **W**  **Index Variante**

type **DVT 3.100-XX**

frequency  Hz

speed  min<sup>-1</sup>

power required  kW

inlet capacity  m<sup>3</sup>/h

pressure +  mbar

vacuum -  mbar

MADE IN CHINA

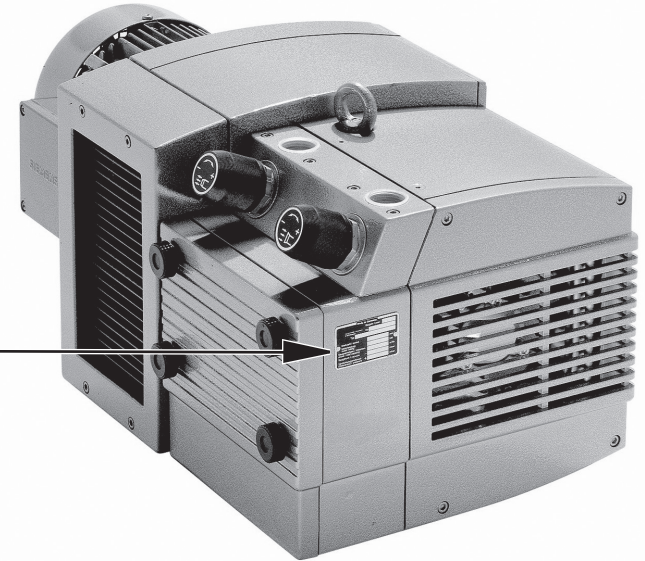

**Ersatzteilliste**  
Spare parts list  
Liste de pièces de rechange  
Listino pezzi di ricambio  
Lista de piezas de recambio  
Lista de peças sobresselentes  
Reserveonderdelenlijst  
Atsarginių dalių sąrašas  
Varuosad nimekirja  
Rezerves daļu saraksts

**Reservdeliste**  
Reservdelista  
Varaosuettelo  
Reservdeliste  
Wykaz części zamiennych  
Tartalékalkatrész lista  
Seznam náhradních dílů  
Seznam nadomestnih delov  
Zoznam náhradných dielov  
Rezervni dijelovi popis

**Lista pieselor de schimb**  
Páirteanna spártha liosta  
Κατάλογος ανταλλακτικών  
Yedek parça listesi  
Списък на резервните части  
Перечень запасных частей  
スベアパーツリスト  
예비 부품 목록  
备用零件目录

# SERVICE

[www.becker-international.com](http://www.becker-international.com)

Sales and service network

**Wartung**  
**Maintenance**  
**Entretien**  
**Manutenzione**  
**Mantenimiento**

Pos.	Menge <sup>2)</sup> Quantity Quantité Quantità Cantidad	Bestell-Nr. Ident No. No. Identification No. Identificazione No. de pedido	Bezeichnung Description Designation Designazione Descripción
□	1	549000 21300	Dichtungssatz, Complete set of seals, Jeu de joints, Kit di guarnizioni, Junta Completa
11	SATZ/KIT	901333 00007	Schieber, Rotor Vane, Palette, Empujador
68	2	909507 00000	Filterpatrone, Filter cartridge, Cartouche Filtrante, Cartuccia filtro, Cartucho de filtro
91	1	909514 00000	Filterpatrone, Filter cartridge, Cartouche Filtrante, Cartuccia filtro, Cartucho de filtro

<sup>2)</sup> erforderliche Bestellmenge / necessary order quantity / quantité nécessaire / quantità di ordinazione necessari / cantidad necesario

**DVT 3.100 Standard**

**Variante**

**DVT 3.100/XX**

①

1.+2.Ansaugung  
1.+2.suction  
1.+2.aspiration  
1.+2.aspirazione  
1.+2.aspiración

②

US-Motoranschluß  
US motor  
US moteur  
US motore  
US motor

③

B5/250-BG112  
- Motoranschluß  
- motor connection  
- connexion (moteur)  
- connessione (motore)  
- conexión (motor)

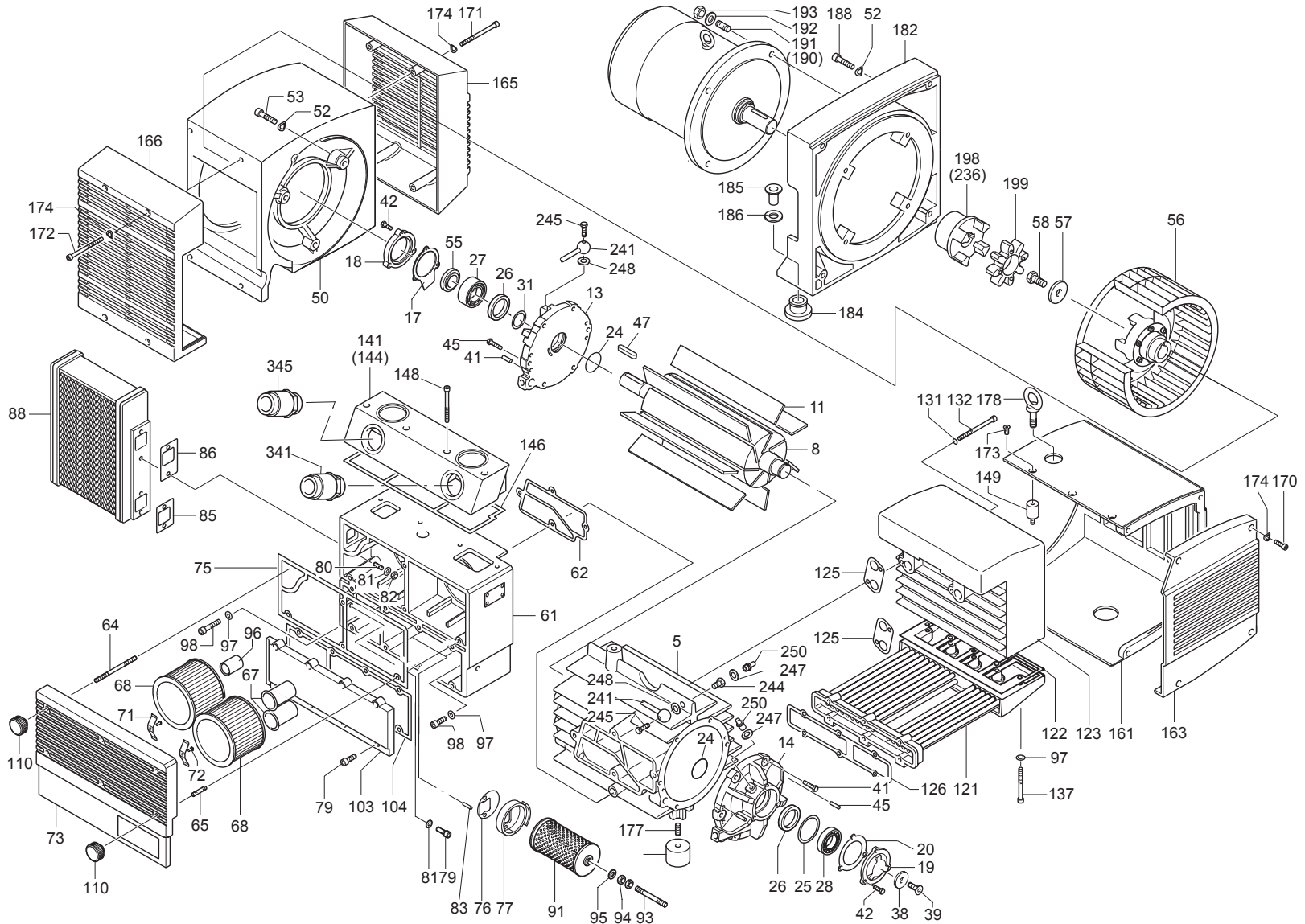
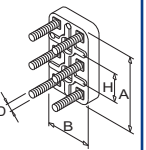
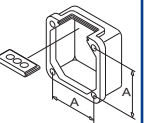
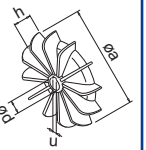
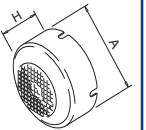
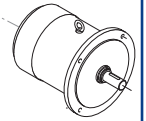

**SERVICE**



W INDEX	Pos.	Bestell Nr.	Beschreibung	DE	
DVT 3.100	■	549000 21300	DICHTUNGSSATZ <sup>1)</sup>		
	5	000100 21200	GEHÄUSE		
	8	020004 21200	KOLBEN		
	11	901333 00007	SCHIEBER (SATZ)		
	13	000802 21200	SEITENDECKEL, LINKS		
	14	000700 21200	SEITENDECKEL, RECHTS		
	17	025512 21200	DICHTUNG		
	18	001100 21200	LAGERDECKEL		
	19	001000 21200	LAGERDECKEL		
	20	025513 21200	DICHTUNG		
	24	911312 00000	DICHTUNGSSCHLAUCH		
	25	917152 00000	AUSGLEICHSCHEIBE		
	26	906540 00000	WELLENDICHRING		
	27	906620 00000	WÄLZLAGER		
	28	906657 00000	WÄLZLAGER		
	31	511400 10100	SATZ DISTANZSCHEIBEN		
	38	016801 21100	SPANNSCHEIBE		
	39	949807 00000	SENKSCRAUBE		
	41	945224 00000	SECHSKANTSCHRAUBE		
	42	945222 00000	SECHSKANTSCHRAUBE		
	45	948742 00000	PASSKERBSTIFT		
	47	947736 00000	PASSFEDER		
	50	053201 21300	LATERNE		
	52	950308 00000	UNTERLEGSCHNEIBE		
	53	945331 00000	INNENSECHSKANTSCHRAUBE		
	55	011400 21200	DISTANZSCHEIBE		
	56	544500 21200	KUPPLUNGSHÄLFTE MIT VENTILATOR		
	57	949409 00000	UNTERLEGSCHNEIBE		
	58	945270 00000	WELLENENDSCHRAUBE		
	61	040102 21300	FILTERGEHÄUSE		
	62	025501 21300	DICHTUNG		
	64	951009 00000	STIFTSCHRAUBE		
	65	951003 00000	STIFTSCHRAUBE		
	67	964407 00000	SCHALLDÄMPFERROHR		
	68	909507 00000	FILTERPATRONE (2x) <sup>2)</sup>		
	71	009000 27000	ANPRESSFEDER		
	72	948750 00000	BLINDNIET		
	73	040204 21300	FILTERDECKEL		
	75	025518 21300	DICHTUNG		
	76	025516 21100	DICHTUNG		
	77	022802 21100	FILTERTRÄGER		
	79	945321 00000	INNENSECHSKANTSCHRAUBE		
	80	946971 00000	STIFTSCHRAUBE		
	81	947504 00000	UNTERLEGSCHNEIBE		
	82	947104 00000	SECHSKANTMUTTER		
	83	952019 00000	SPANNHÜLSE		
	85	025514 21100	DICHTUNG		
	86	025515 21100	DICHTUNG		
	88	560203 21300	KUEHLER		
	91	909514 00000	FILTERPATRONE (1x) <sup>2)</sup>		
	93	903800 70000	STIFTSCHRAUBE		
	94	947105 00000	SECHSKANTMUTTER		
	95	949450 00000	U-SCHNEIBE		
	96	964445 00000	SCHALLDÄMPFERROHR		
	97	950304 00000	U-SCHNEIBE		
	98	945321 00000	INNENSECHSKANTSCHRAUBE		
	103	068801 21300	STAUBABSCHIEDERDECKEL		
	104	025515 21300	DICHTUNG		
	110	921500 50000	HANDGRIFF		
	121	560204 21300	KÜHLER		

W INDEX	Pos.	Bestell Nr.	Beschreibung	DE	
	122	025506 21300	DICHTUNG		
	123	066802 21300	DRUCKANSCHLUSSKASTEN		
	125	025504 21300	DICHTUNG		
	126	025514 21300	DICHTUNG		
	131	948021 00000	DICHRING		
	132	945374 00020	INNENSECHSKANTSCHRAUBE		
	137	945322 00000	INNENSECHSKANTSCHRAUBE		
	141	016604 21300	ANSCHLUSSLEISTE		
	146	025507 21300	DICHTUNG		
	148	945364 00000	INNENSECHSKANTSCHRAUBE		
	149	741310 30000	GUMMIPUFFER		
	161	918300 21300	ABDECKHAUBE		
	163	920800 21300	LUFTLEITRING		
	165	960700 21300	LÜFTERHAUBE		
	166	960701 21300	LÜFTERHAUBE		
	170	945321 00010	INNENSECHSKANTSCHRAUBE		
	171	945371 00010	INNENSECHSKANTSCHRAUBE		
	172	945372 00010	INNENSECHSKANTSCHRAUBE		
	173	949806 00000	SENKSCRAUBE		
	174	951703 00000	FEDERSCHNEIBE		
	176	741302 00000	GUMMIPUFFER		
	177	945634 00000	GEWINDESTIFT		
	178	948802 00000	RINGSCHRAUBE		
	182	014903 21300	ZWISCHENFLANSCH (B5-300)		
	184	951916 00000	KABELTÜLLE		
	185	948772 00000	ROHRNIETE		
	186	947508 00000	UNTERLEGSCHNEIBE		
	188	945335 00000	INNENSECHSKANTSCHRAUBE		
	191	951022 00000	STIFTSCHRAUBE		
	192	947506 00000	UNTERLEGSCHNEIBE		
	193	947106 00000	SECHSKANTMUTTER		
	198	902100 21900	KUPPLUNGSHÄLFTE (MOT)		
	199	902210 00000	KUPPLUNGSSCHNEIBE		
	241	012200 21200	LEITUNG		
	244	912300 00000	ANSCHLUSSSCHRAUBE		
	245	009400 19000	KUGELSTÜCKSCHRAUBE		
	247	948074 00000	DICHRING		
	248	948021 00000	DICHRING		
	250	949002 00000	SCHMIERNIPPEL		
	341	736000 99624	VAKUUMREGULIERVENTIL (-0,6 BAR)		
	345	728000 99622	DRUCKREGULIERVENTIL (+0,6 BAR)		
		743303 00000	SPEZIALFETT (FETTPRESSE, 50g)		

<sup>1)</sup> Dichtungssatz - 54900021300 - Pos.: 17, 20, 24, 62, 75, 76, 85, 86, 104, 122, 125, 126, 146

<sup>2)</sup> erforderliche Bestellmenge / Wartung

W INDEX	Pos.	Ident No.	Description	
DVT 3.100	■	549000 21300	<b>GASKET SET</b> <sup>1)</sup>	
	5	000100 21200	PUMP BODY	
	8	020004 21200	ROTOR	
	11	901333 00007	<b>CARBON VANES (KIT)</b>	
	13	000802 21200	LID, LEFT	
	14	000700 21200	LID, RIGHT	
	17	025512 21200	GASKET	
	18	001100 21200	BEARING COVER	
	19	001000 21200	BEARING COVER	
	20	025513 21200	GASKET	
	24	911312 00000	SEAL	
	25	917152 00000	COMPENSATING DISC	
26	906540 00000	SHAFT-SEALING RING		
27	906620 00000	BALL BEARING		
28	906657 00000	BALL BEARING		
31	511400 10100	SET DISTANCE DISC		
38	016801 21100	CLAMPING DISC		
39	949807 00000	SCREW		
41	945224 00000	HEX-HEAD SCREW		
42	945222 00000	HEX-HEAD SCREW		
45	948742 00000	STRAIGHT PIN		
47	947736 00000	KEY		
50	053201 21300	CONNECTION FLANGE		
52	950308 00000	WASHER		
53	945331 00000	SOCKET HEAD SCREW		
55	011400 21200	DISTANCE DISC		
56	544500 21200	COUPLING WITH FAN		
57	949409 00000	WASHER		
58	945270 00000	SHAFT END BOLD		
61	040102 21300	FILTER HOUSING		
62	025501 21300	GASKET		
64	951009 00000	STUD		
65	951003 00000	STUD		
67	964407 00000	SILENCER TUBE		
68	909507 00000	<b>FILTER CARTRIDGE (2x)</b> <sup>2)</sup>		
71	009000 27000	LEAF SPRING		
72	948750 00000	BLIND RIVET		
73	040204 21300	FILTER COVER		
75	025518 21300	GASKET		
76	025516 21100	GASKET		
77	022802 21100	FILTER HOLDER		
79	945321 00000	SOCKET HEAD SCREW		
80	946971 00000	STUD		
81	947504 00000	WASHER		
82	947104 00000	HEX.NUT		
83	952019 00000	LOCATING PEG		
85	025514 21100	GASKET		
86	025515 21100	GASKET		
88	560203 21300	COOLER		
91	909514 00000	<b>FILTER CARTRIDGE (1x)</b> <sup>2)</sup>		
93	903800 70000	STUD		
94	947105 00000	HEX.NUT		
95	949450 00000	WASHER		
96	964445 00000	SILENCER TUBE		
97	950304 00000	WASHER		
98	945321 00000	SOCKET HEAD SCREW		
103	068801 21300	DUST SEPARATOR COVER		
104	025515 21300	GASKET		
110	921500 50000	HANDLE		
121	560204 21300	COOLER		

W INDEX	Pos.	Ident No.	Description	
	122	025506 21300	GASKET	
	123	066802 21300	PRESSURE CONNECTION BOX	
	125	025504 21300	GASKET	
	126	025514 21300	GASKET	
	131	948021 00000	SEALING RING	
	132	945374 00020	SOCKET HEAD SCREW	
	137	945322 00000	SOCKET HEAD SCREW	
	141	016604 21300	CONNECTING PIECE	
	146	025507 21300	GASKET	
	148	945364 00000	SOCKET HEAD SCREW	
	149	741310 30000	RUBBER BUFFER	
	161	918300 21300	COVERING HOOD	
	163	920800 21300	AIR GUIDE COVER RING	
	165	960700 21300	VENTILATOR HOOD	
	166	960701 21300	VENTILATOR HOOD	
	170	945321 00010	SOCKET HEAD SCREW	
	171	945371 00010	SOCKET HEAD SCREW	
	172	945372 00010	SOCKET HEAD SCREW	
	173	949806 00000	SCREW	
	174	951703 00000	SPRING DISC	
	176	741302 00000	RUBBER BUFFER	
	177	945634 00000	THREADED PIN	
	178	948802 00000	RING SCREW	
	182	014903 21300	FLANGE (B5-300)	
	184	951916 00000	RUBBER BUSHING	
	185	948772 00000	PIPE RIVET	
	186	947508 00000	WASHER	
	188	945335 00000	SOCKET HEAD SCREW	
	191	951022 00000	STUD	
	192	947506 00000	WASHER	
	193	947106 00000	HEX.NUT	
	198	902100 21900	COUPLING (MOT)	
	199	902210 00000	COUPLING DISC	
	241	012200 21200	OIL-PIPE	
	244	912300 00000	CONNECTING SCREW	
	245	009400 19000	HOLLOW HOLDING SCREW	
	247	948074 00000	SEALING RING	
	248	948021 00000	SEALING RING	
	250	949002 00000	GREASE NIPPLE	
	341	736000 99624	VACUUM REGULATION VALVE (-8,7 PSI)	
	345	728000 99622	PRESSURE REGULATION VALVE (+8,7 PSI)	
		743303 00000	<b>SPECIAL GREASE (GREASE PRESS, 50g)</b>	

<sup>1)</sup> Set of seals - 54900021300 - Pos.: 17, 20, 24, 62, 75, 76, 85, 86, 104, 122, 125, 126, 146

<sup>2)</sup> necessary order quantity / maintenance



W INDICE	Pos.	No. Identification	Designation	FR	
DVT 3.100	■	549000 21300	JEU DE JOINTS <sup>1)</sup>		
	5	000100 21200	CORP DE POMPE		
	8	020004 21200	PISTON		
	11	901333 00007	PALETTE DE CHARBON (KIT)		
	13	000802 21200	COUVERCLE A GAUCHE		
	14	000700 21200	COUVERCLE A DROITE		
	17	025512 21200	JOINT		
	18	001100 21200	COUVERCLE DE ROULEMENTE		
	19	001000 21200	COUVERCLE DE ROULEMENTE		
	20	025513 21200	JOINT		
	24	911312 00000	JOINT		
	25	917152 00000	DISQUE DE COMPENSATION		
	26	906540 00000	BAGUE D'ETANCHEITE P.L'AXE		
	27	906620 00000	ROULEMENT A BILLES		
	28	906657 00000	ROULEMENT A BILLES		
	31	511400 10100	JEU DISQUE DE TOLERANCE		
	38	016801 21100	DISQUE DE SERRAGE		
	39	949807 00000	VIS		
	41	945224 00000	VIS HEXAGONALE		
	42	945222 00000	VIS HEXAGONALE		
	45	948742 00000	GOUPILLE CYLINDRIQUE		
	47	947736 00000	CLAVETTE		
	50	053201 21300	BRIDE DE RACCORDEMENT		
	52	950308 00000	RONDELLE		
	53	945331 00000	VIS HEXAGONALE INTERNE		
	55	011400 21200	DISQUE DE TOLERANCE		
	56	544500 21200	ACCOUPLLEMENT AVEC VENTILATEUR		
	57	949409 00000	RONDELLE		
	58	945270 00000	VIS BOUT D'ARBRE		
	61	040102 21300	BOITE POUR FILTRE		
	62	025501 21300	JOINT		
	64	951009 00000	PRISONNIER		
	65	951003 00000	PRISONNIER		
	67	964407 00000	TUBE SILENCIEUX		
	68	909507 00000	CARTOUCHE FILTRANTE (2x) <sup>2)</sup>		
	71	009000 27000	RESSORT-JAME		
	72	948750 00000	RIVET AVEUGLIE		
	73	040204 21300	COUVERCLE DE FILTRE		
	75	025518 21300	JOINT		
	76	025516 21100	JOINT		
	77	022802 21100	SUPPORT FILTRE		
	79	945321 00000	VIS HEXAGONALE INTERNE		
	80	946971 00000	PRISONNIER		
	81	947504 00000	RONDELLE		
	82	947104 00000	ECROU A 6 PANS		
	83	952019 00000	DOUILLE DE ETRAGE		
	85	025514 21100	JOINT		
	86	025515 21100	JOINT		
	88	560203 21300	REFROIDISSEUR		
	91	909514 00000	CARTOUCHE FILTRANTE (1x) <sup>2)</sup>		
	93	903800 70000	PRISONNIER		
	94	947105 00000	ECROU A 6 PANS		
	95	949450 00000	RONDELLE		
	96	964445 00000	TUBE SILENCIEUX		
	97	950304 00000	RONDELLE		
	98	945321 00000	VIS HEXAGONALE INTERNE		
	103	068801 21300	COUVERCLE		
	104	025515 21300	JOINT		
	110	921500 50000	POIGNEE		
	121	560204 21300	REFROIDISSEUR		

W INDICE	Pos.	No. Identification	Designation	FR	
	122	025506 21300	JOINT		
	123	066802 21300	BOITIER DE RACCORD DE REFOULEMENT		
	125	025504 21300	JOINT		
	126	025514 21300	JOINT		
	131	948021 00000	JOINT		
	132	945374 00020	VIS HEXAGONALE INTERNE		
	137	945322 00000	VIS HEXAGONALE INTERNE		
	141	016604 21300	PIECE RACCORD		
	146	025507 21300	JOINT		
	148	945364 00000	VIS HEXAGONALE INTERNE		
	149	741310 30000	AMORTISSEUR EN CAOUTCHOUC		
	161	918300 21300	CARTER		
	163	920800 21300	CAPOT DE CANALISATION DE L'AIR		
	165	960700 21300	CARTER DE VENTILATEUR		
	166	960701 21300	CARTER DE VENTILATEUR		
	170	945321 00010	VIS HEXAGONALE INTERNE		
	171	945371 00010	VIS HEXAGONALE INTERNE		
	172	945372 00010	VIS HEXAGONALE INTERNE		
	173	949806 00000	VIS A TÊTE NOYÉE		
	174	951703 00000	DISQUE DE RESSORT		
	176	741302 00000	AMORTISSEUR EN CAOUTCHOUC		
	177	945634 00000	GOUPILLE FILETEE		
	178	948802 00000	PITON		
	182	014903 21300	BRIDE (B5-300)		
	184	951916 00000	PROTECTION EN CAOUTCHOUC		
	185	948772 00000	RIVET TUBE		
	186	947508 00000	RONDELLE		
	188	945335 00000	VIS HEXAGONALE INTERNE		
	191	951022 00000	PRISONNIER		
	192	947506 00000	RONDELLE		
	193	947106 00000	ECROU A 6 PANS		
	198	902100 21900	ACCOUPLLEMENT		
	199	902210 00000	DISQUE D'ACCOUPLLEMENT		
	241	012200 21200	TUYEAU DE GRAISSAGE		
	244	912300 00000	VIS DE RACCORD		
	245	009400 19000	VIS CREUSE DE FIXATION		
	247	948074 00000	JOINT		
	248	948021 00000	JOINT		
	250	949002 00000	GRAISSEUR		
	341	736000 99624	SOUPAPE REGLAGE VIDE (-0,6 BAR)		
	345	728000 99622	SOUPAPE REGLAGE PRESSION (+0,6 BAR)		
		743303 00000	<b>GRAISSE SPÉCIFIQUE (POMPE À GRAISSE, 50g)</b>		

<sup>1)</sup> Jeu de joints - 54900021300 - Pos.: 17, 20, 24, 62, 75, 76, 85, 86, 104, 122, 125, 126, 146

<sup>2)</sup> quantité nécessaire / entretien



W INDICE	Pos.	No. Identificazione	Designazione	IT	
DVT 3.100	■	549000 21300	<b>KIT GUARNIZIONI <sup>1)</sup></b>		
	5	000100 21200	CARCASSA		
	8	020004 21200	ROTORE		
	11	901333 00007	<b>PALETTE DI CHARBONE (KIT)</b>		
	13	000802 21200	COPERCHIO SINISTRA		
	14	000700 21200	COPERCHIO DESTRA		
	17	025512 21200	GUARNIZIONE		
	18	001100 21200	COPERCHIO CUSCINETTO		
	19	001000 21200	COPERCHIO CUSCINETTO		
	20	025513 21200	GUARNIZIONE		
	24	911312 00000	GUARNIZIONE		
	25	917152 00000	DISCO COMPENSATORE		
	26	906540 00000	GUARNIZIONE PER L'ALBERO		
	27	906620 00000	CUSCINETTO A SFERA		
	28	906657 00000	CUSCINETTO A SFERA		
	31	511400 10100	SERIE DISCO GIUOCO		
	38	016801 21100	DISCO DI FISSAGGIO		
	39	949807 00000	VITE		
	41	945224 00000	VITE ESAGONALE		
	42	945222 00000	VITE ESAGONALE		
	45	948742 00000	PERNO		
47	947736 00000	CHIAVETTA			
50	053201 21300	FLANGIA DI RACCORDE			
52	950308 00000	RONDELLA			
53	945331 00000	VITE ESAGONALE INTERNA			
55	011400 21200	DISCO GIUOCO			
56	544500 21200	GIUNTO CON VENTILATORE			
57	949409 00000	RONDELLA			
58	945270 00000	VITE DI CHIUSURA ALBERO			
61	040102 21300	CONTENITORE FILTRO			
62	025501 21300	GUARNIZIONE			
64	951009 00000	L'ASTA A VITE			
65	951003 00000	L'ASTA A VITE			
67	964407 00000	TUBO SILENZIATORE			
68	909507 00000	<b>CARTUCCIA FILTRO (2x) <sup>2)</sup></b>			
71	009000 27000	MOLLA			
72	948750 00000	RIVETTO CIECO			
73	040204 21300	COPERCHIO FILTRO			
75	025518 21300	GUARNIZIONE			
76	025516 21100	GUARNIZIONE			
77	022802 21100	SUPPORTO FILTRO			
79	945321 00000	VITE ESAGONALE INTERNA			
80	946971 00000	L'ASTA A VITE			
81	947504 00000	RONDELLA			
82	947104 00000	DADO ESAGONALE			
83	952019 00000	SPINE DI RISCONTRO			
85	025514 21100	GUARNIZIONE			
86	025515 21100	GUARNIZIONE			
88	560203 21300	RAFFREDDATORE			
91	909514 00000	<b>CARTUCCIA FILTRO (1x) <sup>2)</sup></b>			
93	903800 70000	L'ASTA A VITE			
94	947105 00000	DADO ESAGONALE			
95	949450 00000	RONDELLA			
96	964445 00000	TUBO SILENZIATORE			
97	950304 00000	RONDELLA			
98	945321 00000	VITE ESAGONALE INTERNA			
103	068801 21300	COPERCHIO			
104	025515 21300	GUARNIZIONI			
110	921500 50000	MANETTA			
121	560204 21300	RAFFREDDATORE			

W INDICE	Pos.	No. Identificazione	Designazione	IT	
	122	025506 21300	GUARNIZIONE		
	123	066802 21300	SCATOLA DI RACCORDO DI MANDATA		
	125	025504 21300	GUARNIZIONE		
	126	025514 21300	GUARNIZIONI		
	131	948021 00000	ANELLO GUARNIZIONE		
	132	945374 00020	VITE ESAGONALE INTERNA		
	137	945322 00000	VITE ESAGONALE INTERNA		
	141	016604 21300	PEZZI RACCORDI		
	146	025507 21300	GUARNIZIONE		
	148	945364 00000	VITE ESAGONALE INTERNA		
	149	741310 30000	AMMORTIZZATORE IN GOMMA		
	161	918300 21300	CARTER		
	163	920800 21300	CAPPOTTA DEL CONDOTTA ARIA		
	165	960700 21300	CARTER VENTILATORE		
	166	960701 21300	CARTER VENTILATORE		
	170	945321 00010	VITE ESAGONALE INTERNA		
	171	945371 00010	VITE ESAGONALE INTERNA		
	172	945372 00010	VITE ESAGONALE INTERNA		
	173	949806 00000	VITE A TESTA SVASATA		
	174	951703 00000	DISCO A MOLLA		
	176	741302 00000	AMMORTIZZATORE IN GOMMA		
	177	945634 00000	SPINA FILETTATURA		
	178	948802 00000	GANCIO		
	182	014903 21300	FLANGIA (B5-300)		
	184	951916 00000	PROTEZIONE IN GOMMA		
	185	948772 00000	CHiodo TUBOLARE		
	186	947508 00000	RONDELLA		
	188	945335 00000	VITE ESAGONALE INTERNA		
	191	951022 00000	L'ASTA A VITE		
	192	947506 00000	RONDELLA		
	193	947106 00000	DADO ESAGONALE		
	198	902100 21900	GIUNTO		
	199	902210 00000	DISCO GIUNTO		
	241	012200 21200	CONDOTTO		
	244	912300 00000	ATTACO FILETTATO		
	245	009400 19000	VITE PASSAGGIO OLIO		
	247	948074 00000	ANELLO GUARNIZIONE		
	248	948021 00000	ANELLO GUARNIZIONE		
	250	949002 00000	RACCORDO DI LUBRIFICAZIONE		
	341	736000 99624	VALVOLA REGOLAZIONE VUOTO (-0,6 BAR)		
	345	728000 99622	VALVOLA REGOLAZIONE PRESSIONE (+0,6 BAR)		
		743303 00000	<b>GRASSO SPECIALE (INGRASSATORE A PISTOLA, 50g)</b>		

<sup>1)</sup> Serie di guarnizione - 54900021300 - Pos.: 17, 20, 24, 62, 75, 76, 85, 86, 104, 122, 125, 126, 146

<sup>2)</sup> quantità di ordinazione necessari / manutenzione



DVT 3.100	Variante 	Pos.	Bestell Nr. / Ident No. / No. Identification / No. Identificazione / No. De pedido		Beschreibung / Description / Designation / Designazione / Desripcion
					
① <b>1.+2.Ansaugung</b> <b>1.+2.suction</b> <b>1.+2.aspiration</b> <b>1.+2.aspirazione</b> <b>1.+2.aspiración</b>		96		964445-00000	SCHALLDÄMPFERROHR / SILENCER TUBE / TUBE SILENCIEUX / TUBO SILENZIATORE / TUBO DE SILENCIADOR
		141		016604-21300	ANSCHLUSSLEISTE / CONNECTING PIECE / PIECE RACCORD / PEZZI RACCORDI / PIEZA DE EMPALME
		144	016603 21300		ANSCHLUSSLEISTE / CONNECTING PIECE / PIECE RACCORD / PEZZI RACCORDI / PIEZA DE EMPALME
		342	736000 99613		VAKUUMREGULIERVENTIL (-0,3 BAR) / VACUUM REGULATION VALVE (-4,35 PSI) / SOUPAPE REGLAGE VIDE (-0,3 BAR) / VALVOLA REGOLAZIONE VUOTO (-0,3 BAR) / VÁLVULA REGULADORA DE VACÍO (-0,3 BAR)
② <b>US Motoranschluß</b> <b>US motor</b> <b>US moteur</b> <b>US motore</b> <b>US motor</b>		190	951018 00000		STIFTSCHRAUBE / STUD / PRISONNIER / L'ASTA A VITE / ESPÁRRAGO
		191		951022-00000	STIFTSCHRAUBE / STUD / PRISONNIER / L'ASTA A VITE / ESPÁRRAGO
		198		902100-21900	KUPPLUNGSHÄLFTE (MOT) / COUPLING (MOT) / ACCOUPLEMENT (MOT) / GIUNTO (MOT) / MITAD DE ACOPLAMIENTO (MOT)
		234	037900 10400		ZWISCHENFLANSCH / FLANGE / BRIDE / FLANGIA / BRIDA INTERMEDIA
		236	902100 21300		KUPPLUNGSHÄLFTE (MOT) / COUPLING (MOT) / ACCOUPLEMENT (MOT) / GIUNTO (MOT) / MITAD DE ACOPLAMIENTO (MOT)
③ <b>B5/250-BG112</b> - Motoranschluß - motor connection - connexion (moteur) - connessione (motore) - conexión (motor)		182	014902 21300	014903-21300	ZWISCHENFLANSCH / FLANGE / BRIDE / FLANGIA / BRIDA INTERMEDIA
		190	951018 00000	-	STIFTSCHRAUBE / STUD / PRISONNIER / L'ASTA A VITE / ESPÁRRAGO
		191		951022-00000	STIFTSCHRAUBE / STUD / PRISONNIER / L'ASTA A VITE / ESPÁRRAGO
		198	902108 00000	902100-21900	KUPPLUNGSHÄLFTE (MOT) / COUPLING (MOT) / ACCOUPLEMENT (MOT) / GIUNTO (MOT) / MITAD DE ACOPLAMIENTO (MOT)

<sup>2)</sup> variantenabhängige Bauteile / variant-dependent components / composants variante-dependantes / componenti variante-dispendenti / componentes variante-dependientes