

SV 300/1  
SV 300/2  
SV 300/3

**BECKER**  
D-42279 Wuppertal  
www.becker-international.com

No. **A** ← year XXXX

type **SV 300-XX** ← Index Variante

frequency XXXX Hz  
speed XXXX min<sup>-1</sup>  
power required XXXX kW  
inlet capacity XXXX m<sup>3</sup>/h  
pressure + XXXX mbar  
vacuum - XXXX mbar

Made in Germany



Ersatzteilliste  
Spare parts list  
Liste de pièces de rechange  
Listino pezzi di ricambio  
Lista de piezas de recambio  
Lista de peças sobresselentes  
Reserveonderdelenlijst  
Atsarginių dalių sąrašas  
Varuosad nimekirja  
Rezerves daļu saraksts

Reservdeliste  
Reservdelista  
Varaosuettelo  
Reservdeliste  
Wykaz części zamiennych  
Tartalékalkatrész lista  
Seznam náhradních dílů  
Seznam nadomestnih delov  
Zoznam náhradných dielov  
Rezervni dijelovi popis

Lista pieselor de schimb  
Páirteanna spártha liosta  
Κατάλογος ανταλλακτικών  
Yedek parça listesi  
Списък на резервните части  
Перечень запасных частей  
スペアパーツリスト  
예비 부품 목록  
备用零件目录

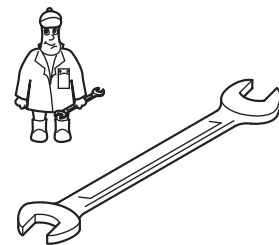

Wartung  
Maintenance  
Entretien  
Manutenzione  
Mantenimiento

Pos.	Menge <sup>1)</sup> Quantity Quantité Quantità Cantidad	Bestell-Nr. Ident No. No. Identification No. Identificazione No. de pedido	Bezeichnung Description Designation Designazione Descripción
<b>K1</b>	1	966900 60500	Schraubensatz, Screw kit, Kit de visserie, Kit di viti, Kit de tornillo
349	1	909510 30000	Filterpatrone, filter cartridge, cartouche filtrante, cannuccia filtrante, cartucho filtrante
349.1	1	909510 30001 <sup>2)</sup>	Filterpatrone, filter cartridge, cartouche filtrante, cannuccia filtrante, cartucho filtrante
914	1	909573 00000	Ansaugfilter, suction filter, filtre d'aspiration, filtro d'aspirazione, filtro de aspiración

<sup>1)</sup> erforderliche Bestellmenge / necessary order quantity / quantité nécessaire / quantità di ordinazione necessari / cantidad necesario

<sup>2)</sup> Polyester / polyester / polyester / poliester / poliéster

SV 300/1  
SV 300/2  
SV 300/3

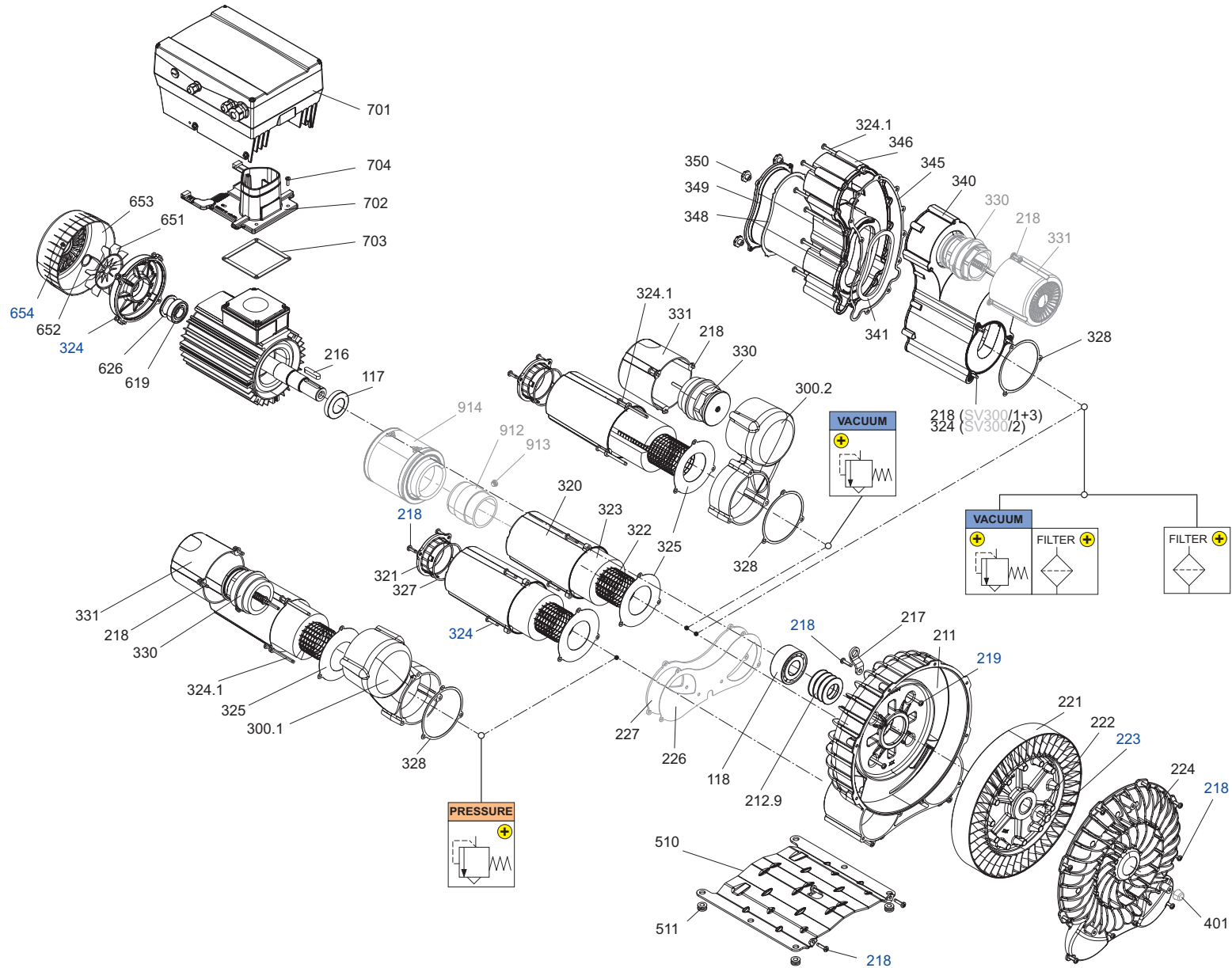

SERVICE ?

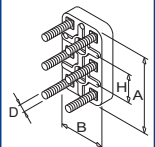
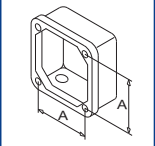
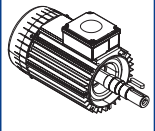

<b>A</b> INDEX	Pos.	Bestell Nr.	Beschreibung	
<b>SV 300/X</b>	<b>K1</b>	966900 60500	<b>SCHRAUBENSATZ</b>	9)
	117	013900 60300	DISTANZBUCHSE (SV300/1+3)	
	118	906616 50000	LAGER - GBB41 1) (SV300/1+3)	
	118	906619 40000	LAGER - GBB45 1) (SV300/2)	
	211	500100 60300	GEHÄUSE (SV300/1+3)	
	211	500110 60300	GEHÄUSE 8) (SV300/1)	
	211	500101 60300	GEHÄUSE (SV300/2)	
	211	500111 60300	GEHÄUSE 8) (SV300/2)	
	212.9	511400 60300	DISTANZSCHEIBENSATZ	
	216	947742 00000	PASSFEDER, 10X8X45	
	217	025100 60300	TRANSPORTVORRICHTUNG	
	218	K1	SCHRAUBE, M6X20	
	219	K1	SCHRAUBE, M6X50	
	221	000602 60300	LAUFRAD	
	221	000612 60300	LAUFRAD 6)	
	221	000600 60300	LAUFRAD 7)	
	221	000610 60300	LAUFRAD 6) + 7)	
	221	508200 60300	LAUFRAD (SV300/3)	
	222	960612 00000	UNTERLEGSSCHEIBE, 11X40X5	
	223	K1	WELLENENDSCHRAUBE	
	224	000200 60300	GEHÄUSEDECKEL	
	224	000210 60300	GEHÄUSEDECKEL 6)	
	226	907500 60300	DICHTUNG (1x) (SV300/2)	
	226	907502 60300	DICHTUNG (2x) (SV300/3)	
	227	003600 60300	ZWISCHENFLANSCH (1x) (SV300/2)	
	227	003601 60300	ZWISCHENFLANSCH (2x) (SV300/3)	
	300.1	016601 60300	ANSCHLUSSSTÜCK 2)	
	300.1	016611 60300	ANSCHLUSSSTÜCK 2) + 6)	
	300.2	016600 60300	ANSCHLUSSSTÜCK 3)	
	300.2	016610 60300	ANSCHLUSSSTÜCK 3) + 6)	
	320	007400 60300	SCHALLDÄMPFERGEHÄUSE	
	320	007410 60300	SCHALLDÄMPFERGEHÄUSE 6)	
	321	007800 60300	GEWINDEFLENSCH	
	322	907601 70000	SIEBROHR	
	323	907706 30000	DÄMPFER	
	324	K1	SCHRAUBE, M6X30	
	324.1	946511 00000	SCHRAUBE, M6X90	
	325	907501 60300	DICHTUNG	
	327	913122 20000	O-RING	
328	907506 60300	DICHTUNG 2) + 3) + 4) + 5)		
330	733700 99609	VENTILEINSATZ (150-240MBAR) 2) + 3) + 5)		
330	733701 99609	VENTILEINSATZ (240-420MBAR) 2) + 3) + 5)		
330	733702 99609	VENTILEINSATZ (420-550MBAR) 2) + 3)		
331	040200 60300	VENTILDECKEL 2) + 3) + 5)		
332	946508 00000	SCHRAUBE, M6X20		
340	040100 60300	FILTERGEHÄUSE 4)		
340	040101 60300	FILTERGEHÄUSE 5)		
341	907505 60300	DICHTUNG 4) + 5)		
345	907503 60300	DICHTUNG 4) + 5)		
346	040201 60300	FILTERDECKEL 4) + 5)		
348	907504 60300	DICHTUNG 4) + 5)		
349	909510 30000	FILTERPATRONE (PAPIER) 4) + 5)		

<b>A</b> INDEX	Pos.	Bestell Nr.	Beschreibung	
	349	909510 30001	FILTERPATRONE (POLYESTER) 4) + 5)	
	350	921503 00000	STERNGRIFF 4) + 5)	
	401	741315 00000	GUMMIPUFFER OPTIONAL	
	510	015100 60300	FUSS	
	511	951931 00000	GUMMIFORMTEIL	
	619	906610 00000	LAGER - GBB41 1)	
	626	917191 00000	WELLENFEDER	
	651	002300 60300	MOTOR-VENTILATOR	
	651	002300 60400	MOTOR-VENTILATOR 8)	
	652	948101 00000	SEEGERRING	
	652	948130 00000	SEEGERRING 8)	
	653	960701 60300	HAUBE	
	653	960701 60400	HAUBE 8)	
	654	K1	SCHRAUBE, M4X5	
	701	796302 51115	FREQUENZUMRICHTER 7)	
	702	003602 55115	ADAPTERPLATTE 7)	
	703	025500 45000	DICHTUNG 7)	
	704	945308 00000	SCHRAUBE, M5X20 7)	
	912	739200 37100	SCHLAUCHSTUTZEN OPTIONAL	
	913	951204 00000	VERSCHLUSSSCHRAUBE OPTIONAL	
	914	909573 00000	ANSAUGFILTER OPTIONAL	

1) Lager sind mit Spezialfett gefüllt. Nur durch Original der Firma Gebr. Becker ersetzen.  
2) nur bei Ausführung mit Drucksicherheitsventil DS, 3) nur bei Ausführung mit Vakuumsicherheitsventil VS  
4) nur bei Ausführung mit Ansaugfilter F, 5) nur bei Ausführung mit Ansaugfilter und Vakuumsicherheitsventil VSF  
6) mit Korrosionsschutz, 7) nur bei Ausführung mit Frequenzumrichter, 8) nur bei Ausführung mit 4,0/4,8 kW Motor  
9) **K1** - 966900 60500 → **Pos.:** 218, 219, 223, 324, 654

<b>A</b> INDEX	Pos.	Ident No.	Description	
<b>SV 300/X</b>	<b>K1</b>	966900 60500	<b>SCREW KIT</b>	<sup>9)</sup>
	117	013900 60300	SPACER SLEEVE	(SV300/1+3)
	118	906616 50000	BEARING - GBB41	<sup>1)</sup> (SV300/1+3)
	118	906619 40000	BEARING - GBB45	<sup>1)</sup> (SV300/2)
	211	500100 60300	HOUSING	(SV300/1+3)
	211	500110 60300	HOUSING	<sup>6)</sup> (SV300/1)
	211	500101 60300	HOUSING	(SV300/2)
	211	500111 60300	HOUSING	<sup>6)</sup> (SV300/2)
	212.9	511400 60300	SET OF SPACERS	
	216	947742 00000	KEY, 10X8X45	
	217	025100 60300	TRANSPORT DEVICE	
	218	K1	SCREW, M6X20	
	219	K1	SCREW, M6X50	
	221	000602 60300	IMPELLER	
	221	000612 60300	IMPELLER	<sup>6)</sup>
	221	000600 60300	IMPELLER	<sup>7)</sup>
	221	000610 60300	IMPELLER	<sup>6) + 7)</sup>
	221	508200 60300	IMPELLER	(SV300/3)
	222	960612 00000	WASHER, 11X40X5	
	223	K1	HEX HEAD SCREW	
	224	000200 60300	HOUSING LID	
	224	000210 60300	HOUSING LID	<sup>6)</sup>
	226	907500 60300	GASKET (1x)	(SV300/2)
	226	907502 60300	GASKET (2x)	(SV300/3)
	227	003600 60300	INTERMEDIATE FLANGE (1x)	(SV300/2)
	227	003601 60300	INTERMEDIATE FLANGE (2x)	(SV300/3)
	300.1	016601 60300	FITTING	<sup>2)</sup>
	300.1	016611 60300	FITTING	<sup>2) + 6)</sup>
	300.2	016600 60300	FITTING	<sup>3)</sup>
	300.2	016610 60300	FITTING	<sup>3) + 6)</sup>
	320	007400 60300	SILENCER HOUSING	
	320	007410 60300	SILENCER HOUSING	<sup>6)</sup>
	321	007800 60300	SCREWED FLANGE	
	322	907601 70000	SIEVE-TUBE	
	323	907706 30000	SILENCER MATERIAL	
	324	K1	SCREW, M6X30	
	324.1	946511 00000	SCREW, M6X90	
	325	907501 60300	GASKET	
	327	913122 20000	O-RING SEAL	
328	907506 60300	GASKET	<sup>2) + 3) + 4) + 5)</sup>	
330	733700 99609	VALVE INSERT (150-240MBAR)	<sup>2) + 3) + 5)</sup>	
330	733701 99609	VALVE INSERT (240-420MBAR)	<sup>2) + 3) + 5)</sup>	
330	733702 99609	VALVE INSERT (420-550MBAR)	<sup>2) + 3)</sup>	
331	040200 60300	VALVE COVER	<sup>2) + 3) + 5)</sup>	
332	946508 00000	SCREW, M6X20		
340	040100 60300	FILTER HOUSING	<sup>4)</sup>	
340	040101 60300	FILTER HOUSING	<sup>5)</sup>	
341	907505 60300	GASKET	<sup>4) + 5)</sup>	
345	907503 60300	GASKET	<sup>4) + 5)</sup>	
346	040201 60300	FILTER COVER	<sup>4) + 5)</sup>	
348	907504 60300	GASKET	<sup>4) + 5)</sup>	
349	909510 30000	FILTER CARTRIDGE (PAPER)	<sup>4) + 5)</sup>	

<b>A</b> INDEX	Pos.	Ident No.	Description	
	349	909510 30001	FILTER CARTRIDGE (POLYESTER)	<sup>4) + 5)</sup>
	350	921503 00000	STAR HANDLE	<sup>4) + 5)</sup>
	401	741315 00000	RUBBER BUFFER	OPTIONAL
	510	015100 60300	FOOT	
	511	951931 00000	BUMPER	
	619	906610 00000	BEARING - GBB41	<sup>1)</sup>
	626	917191 00000	SHAFT SPRING	
	651	002300 60300	MOTOR FAN	
	651	002300 60400	MOTOR FAN	<sup>8)</sup>
	652	948101 00000	SEEGER CIRCLIP	
	652	948130 00000	SEEGER CIRCLIP	<sup>8)</sup>
	653	960701 60300	COVER	
	653	960701 60400	COVER	<sup>8)</sup>
	654	K1	SCREW, M4X5	
	701	796302 51115	FREQUENCY CONVERTOR	<sup>8)</sup>
	702	003602 55115	ADAPTER PLATE	<sup>7)</sup>
	703	025500 45000	GASKET	<sup>7)</sup>
	704	945308 00000	SCREW, M5X20	<sup>7)</sup>
	912	739200 37100	HOSE-END FITTING	OPTIONAL
	913	951204 00000	SCREW PLUG	OPTIONAL
	914	909573 00000	SUCTION FILTER	OPTIONAL

<sup>1)</sup> Bearings are filled with special grease. Only be replaced by Gebrüder Beckers original.  
<sup>2)</sup> only for devices with pressure relief valve DS, <sup>3)</sup> only for devices with vacuum relief valve VS  
<sup>4)</sup> only for devices with suction filter F, <sup>5)</sup> only for devices with suction filter and vacuum relief valve VSF,  
<sup>6)</sup> with corrossions protection, <sup>7)</sup> only for devices with frequency convertor, <sup>8)</sup> only for devices with 4,0/4,8 kW motor  
<sup>9)</sup> **K1** - 966900 60500 → **Pos.:** 218, 219, 223, 324, 654

A INDEX	Pos.	No. Identification	Designation	FR	
SV 300/X	K1	966900 60500	KIT DE VISSERIE		9)
	117	013900 60300	DOUILLE D'ÉCARTEMENT	(SV300/1+3)	
	118	906616 50000	COUSSINET - GBB41	1) (SV300/1+3)	
	118	906619 40000	COUSSINET - GBB45	1) (SV300/2)	
	211	500100 60300	CARTER	(SV300/1+3)	
	211	500110 60300	CARTER	6) (SV300/1)	
	211	500101 60300	CARTER	(SV300/2)	
	211	500111 60300	CARTER	6) (SV300/2)	
	212.9	511400 60300	ENSEMBLE D'ESPACEURS		
	216	947742 00000	CLAVETTE, 10X8X45		
	217	025100 60300	DISPOSITIF DE TRANSPORT		
	218	K1	VIS, M6X20		
	219	K1	VIS, M6X50		
	221	000602 60300	ROUE		
	221	000612 60300	ROUE	6)	
	221	000600 60300	ROUE	7)	
	221	000610 60300	ROUE	6) + 7)	
	221	508200 60300	ROUE	(SV300/3)	
	222	960612 00000	RONDELLE, 11X40X5		
	223	K1	VIS SIX-PANS		
	224	000200 60300	COUVERCLE DE CARTER		
	224	000210 60300	COUVERCLE DE CARTER	6)	
	226	907500 60300	JOINT (1x)	(SV300/2)	
	226	907502 60300	JOINT (2x)	(SV300/3)	
	227	003600 60300	BRIDE INTERMÉDIAIRE (1x)	(SV300/2)	
	227	003601 60300	BRIDE INTERMÉDIAIRE (2x)	(SV300/3)	
	300.1	016601 60300	RACCORD	2)	
	300.1	016611 60300	RACCORD	2) + 6)	
	300.2	016600 60300	RACCORD	3)	
	300.2	016610 60300	RACCORD	3) + 6)	
	320	007400 60300	CORPS DE LA SILENCIEUX		
	320	007410 60300	CORPS DE LA SILENCIEUX	6)	
	321	007800 60300	BRIDE FILETÉE		
	322	907601 70000	TUYAU-TAMIS		
	323	907706 30000	SILENCIEUX MATÉRIEL		
	324	K1	VIS, M6X30		
	324.1	946511 00000	VIS, M6X90		
	325	907501 60300	JOINT		
	327	913122 20000	JOINT TORIQUE		
328	907506 60300	JOINT	2) + 3) + 4) + 5)		
330	733700 99609	INSERT DE SOUPAPE (150-240MBAR)	2) + 3) + 5)		
330	733701 99609	INSERT DE SOUPAPE (240-420MBAR)	2) + 3) + 5)		
330	733702 99609	INSERT DE SOUPAPE (420-550MBAR)	2) + 3)		
331	040200 60300	COUVERCLE DE SOUPAPE	2) + 3) + 5)		
332	946508 00000	VIS, M6X20			
340	040100 60300	BOITE POUR FILTRE	4)		
340	040101 60300	BOITE POUR FILTRE	5)		
341	907505 60300	JOINT	4) + 5)		
345	907503 60300	JOINT	4) + 5)		
346	040201 60300	COUVERCLE DU FILTRE	4) + 5)		
348	907504 60300	JOINT	4) + 5)		
349	909510 30000	CARTOUCHE FILTRANTE (PAPIER)	4) + 5)		

A INDEX	Pos.	No. Identification	Designation	FR	
	349	909510 30001	CARTOUCHE FILTRANTE ( POLYESTER)		4) + 5)
	350	921503 00000	POIGNÉE EN ÉTOILE		4) + 5)
	401	741315 00000	AMORTISSEUR CAOUTCHOUC		OPCIONAL
	510	015100 60300	PIED		
	511	951931 00000	AMORTISSEUR CAOUTCHOUC		
	619	906610 00000	COUSSINET - GBB41		1)
	626	917191 00000	ANNEAU RESSORT		
	651	002300 60300	VENTILATEUR DU MOTEUR		
	651	002300 60400	VENTILATEUR DU MOTEUR		8)
	652	948101 00000	FREIN D'AXES SEEGER		
	652	948130 00000	FREIN D'AXES SEEGER		8)
	653	960701 60300	CAPOT		
	653	960701 60400	CAPOT		8)
	654	K1	VIS, M4X5		
	701	796302 51115	CONVERTISSEUR DE FRÉQUENCE		7)
	702	003602 55115	PLATINE D'ADAPTION		7)
	703	025500 45000	JOINT		7)
	704	945308 00000	VIS, M5X20		7)
	912	739200 37100	EMBOUT		OPCIONAL
	913	951204 00000	BOUCHON FILETÉ		OPCIONAL
	914	909573 00000	FILTRE D'ASPIRATION		OPCIONAL

1) Les roulements sont remis d'une graisse spéciale. N'utiliser que de la graisse d'origine de Gebrüder Becker pour la remplacer  
2) uniquement pour les versions avec soupape de surpression DS, 3) uniquement pour les modèles avec soupape de dépression VS  
4) uniquement pour les modèles avec filtre d'aspiration F, 5) uniquement pour les modèles avec filtre d'aspiration et soupape de dépression VSF  
6) avec prot. contre la corrosion, 7) uniquement pour les modèles avec convertisseur de fréquence, 8) uniquement pour les modèles avec moteur 4,0/4,8 kW  
9) K1 - 966900 60500 → Pos.: 218, 219, 223, 324, 654

<b>A</b> INDEX	Pos.	No. Identificazione	Designazione	
<b>SV 300/X</b>	<b>K1</b>	966900 60500	<b>KIT DI VITI</b>	9)
	117	013900 60300	ANELLO DISTANZIATORE (SV300/1+3)	
	118	906616 50000	CUSCINETTO - GBB41 <sup>1)</sup> (SV300/1+3)	
	118	906619 40000	CUSCINETTO - GBB45 <sup>1)</sup> (SV300/2)	
	211	500100 60300	CARCASSA (SV300/1+3)	
	211	500110 60300	CARCASSA <sup>6)</sup> (SV300/1)	
	211	500101 60300	CARCASSA (SV300/2)	
	211	500111 60300	CARCASSA <sup>6)</sup> (SV300/2)	
	212.9	511400 60300	SET DI DISTANZIALI	
	216	947742 00000	CHIAVETTA, 10X8X45	
217	025100 60300	TRASPORTO DISPOSITIVO		
218	K1	VITE, M6X20		
219	K1	VITE, M6X50		
221	000602 60300	GIRANTE		
221	000612 60300	GIRANTE <sup>6)</sup>		
221	000600 60300	GIRANTE <sup>7)</sup>		
221	000610 60300	GIRANTE <sup>6) + 7)</sup>		
221	508200 60300	GIRANTE (SV300/3)		
222	960612 00000	RONDELLA, 11X40X5		
223	K1	VITE ESAGONALE		
224	000200 60300	COPERCHIO DELLA CARCASSA		
224	000210 60300	COPERCHIO DELLA CARCASSA <sup>6)</sup>		
226	907500 60300	GIUNTO (1x) (SV300/2)		
226	907502 60300	GIUNTO (2x) (SV300/3)		
227	003600 60300	FLANGIA INTERMEDIA (1x) (SV300/2)		
227	003601 60300	FLANGIA INTERMEDIA (2x) (SV300/3)		
300.1	016601 60300	PEZZO DI RACCORDO <sup>2)</sup>		
300.1	016611 60300	PEZZO DI RACCORDO <sup>2) + 6)</sup>		
300.2	016600 60300	PEZZO DI RACCORDO <sup>3)</sup>		
300.2	016610 60300	PEZZO DI RACCORDO <sup>3) + 6)</sup>		
320	007400 60300	CORPO DELLA SILENZIATORE		
320	007410 60300	CORPO DELLA SILENZIATORE <sup>6)</sup>		
321	007800 60300	FLANGIA FILETTATA		
322	907601 70000	TUBO-CRIVELLO		
323	907706 30000	SILENZIATORE MATERIALE		
324	K1	VITE, M6X30		
324.1	946511 00000	VITE, M6X90		
325	907501 60300	GIUNTO		
327	913122 20000	GIUNTO CILINDRICO DI TENUTA		
328	907506 60300	GIUNTO <sup>2) + 3) + 4) + 5)</sup>		
330	733700 99609	VALVOLA DI INSERIMENTO (150-240MBAR) <sup>2) + 3) + 5)</sup>		
330	733701 99609	VALVOLA DI INSERIMENTO (240-420MBAR) <sup>2) + 3) + 5)</sup>		
330	733702 99609	VALVOLA DI INSERIMENTO (420-550MBAR) <sup>2) + 3)</sup>		
331	040200 60300	COPERCHIO VALVOLE <sup>2) + 3) + 5)</sup>		
332	946508 00000	VITE, M6X20		
340	040100 60300	CONTENITORE FILTRO A CARTUCCIA <sup>4)</sup>		
340	040101 60300	CONTENITORE FILTRO A CARTUCCIA <sup>5)</sup>		
341	907505 60300	GIUNTO <sup>4) + 5)</sup>		
345	907503 60300	GIUNTO <sup>4) + 5)</sup>		
346	040201 60300	COPERCHIO FILTRO <sup>4) + 5)</sup>		
348	907504 60300	GIUNTO <sup>4) + 5)</sup>		
349	909510 30000	CANNUCCIA FILTRANTE (CARTA) <sup>4) + 5)</sup>		

<b>A</b> INDEX	Pos.	No. Identificazione	Designazione	
	349	909510 30001	CANNUCCIA FILTRANTE (POLIESTERE) <sup>4) + 5)</sup>	
	350	921503 00000	IMPUGNATURA A STELLA <sup>4) + 5)</sup>	
	401	741315 00000	AMMORTIZZATO RE IN GOMMA OPCIONAL	
	510	015100 60300	PIE	
	511	951931 00000	PINGENTE DI GOMMA	
	619	906610 00000	CUSCINETTO - GBB41 <sup>1)</sup>	
	626	917191 00000	ROSETTA ELASTICA	
	651	002300 60300	FAN DAL MOTORE	
	651	002300 60400	FAN DAL MOTORE <sup>8)</sup>	
	652	948101 00000	ANELLO ELASTICO DI SICUREZZA	
	652	948130 00000	ANELLO ELASTICO DI SICUREZZA <sup>8)</sup>	
	653	960701 60300	CALOTTA	
	653	960701 60400	CALOTTA <sup>8)</sup>	
	654	K1	VITE, M4X5	
	701	796302 51115	CONVERTITORE DI FREQUENZA <sup>7)</sup>	
	702	003602 55115	ADATTATORE PIATTO <sup>7)</sup>	
	703	025500 45000	GUARNIZIONE <sup>7)</sup>	
	704	945308 00000	VITE, M5X20 <sup>7)</sup>	
	912	739200 37100	PORTAGOMMA OPCIONAL	
	913	951204 00000	TAPPO A VITE OPCIONAL	
	914	909573 00000	FILTRO D'ASPIRAZIONE OPCIONAL	

<sup>1)</sup> I cuscinetti sono riempiti di grasso speciale. Eseguire il reingrassaggio solo con grasso originale della Gebrüder Becker.  
<sup>2)</sup> solo per le versioni con valvola limitatrice di pressione DS, <sup>3)</sup> solo per le versioni con valvola di sfogo da depressione VS  
<sup>4)</sup> solo per le versioni con filtro d'aspirazione F, <sup>5)</sup> solo per le versioni con filtro d'aspirazione e valvola di sfogo da depressione VSF  
<sup>6)</sup> con protezione anti-corrosione, <sup>7)</sup> solo per le versioni con convertitore di frequenza, <sup>8)</sup> solo per le versioni con motore 4,0/4,8 kW  
<sup>9)</sup> **K1** - 966900 60500 → **Pos.:** 218, 219, 223, 324, 654

<b>A</b> INDICE	Pos.	No. De pedido	Descripción	
<b>SV 300/X</b>	<b>K1</b>	966900 60500	<b>KIT DE TORNILLO</b>	9)
	117	013900 60300	CASQUILLO DISTANCIADOR (SV300/1+3)	
	118	906616 50000	COJINETE - GBB41 <sup>1)</sup> (SV300/1+3)	
	118	906619 40000	COJINETE - GBB45 <sup>1)</sup> (SV300/2)	
	211	500100 60300	CARCASA (SV300/1+3)	
	211	500110 60300	CARCASA <sup>6)</sup> (SV300/1)	
	211	500101 60300	CARCASA (SV300/2)	
	211	500111 60300	CARCASA <sup>6)</sup> (SV300/2)	
	212.9	511400 60300	CONJUNTO DE ESPACIADORES	
	216	947742 00000	CHIAVETTA, 10X8X45	
	217	025100 60300	DISPOSITIVO DE TRANSPORTE	
	218	K1	TORNILLO, M6X20	
	219	K1	TORNILLO, M6X50	
	221	000602 60300	RODETE	
	221	000612 60300	RODETE <sup>6)</sup>	
	221	000600 60300	RODETE <sup>7)</sup>	
	221	000610 60300	RODETE <sup>6) + 7)</sup>	
	221	508200 60300	RODETE (SV300/3)	
	222	960612 00000	ARANDELA, 11X40X5	
	223	K1	TORNILLO DE CABEZA HEXAGONAL	
	224	000200 60300	CUBIERTA DE CARCASA	
224	000210 60300	CUBIERTA DE CARCASA <sup>6)</sup>		
226	907500 60300	JUNTA (1x) (SV300/2)		
226	907502 60300	JUNTA (2x) (SV300/3)		
227	003600 60300	BRIDA INTERMEDIO (1x) (SV300/2)		
227	003601 60300	BRIDA INTERMEDIO (2x) (SV300/3)		
300.1	016601 60300	RACOR <sup>2)</sup>		
300.1	016611 60300	RACOR <sup>2) + 6)</sup>		
300.2	016600 60300	RACOR <sup>3)</sup>		
300.2	016610 60300	RACOR <sup>3) + 6)</sup>		
320	007400 60300	CUERPO DE LA SILENCIADOR		
320	007410 60300	CUERPO DE LA SILENCIADOR <sup>6)</sup>		
321	007800 60300	BRIDA HILADA		
322	907601 70000	TUBO-CRIBA		
323	907706 30000	MATERIAL PARA EL SILENCIADOR		
324	K1	TORNILLO, M6X30		
324.1	946511 00000	TORNILLO, M6X90		
325	907501 60300	JUNTA		
327	913122 20000	JUNTA TOROIDAL		
328	907506 60300	JUNTA <sup>2) + 3) + 4) + 5)</sup>		
330	733700 99609	OBUS DE VÁLVULA (150-240MBAR) <sup>2) + 3) + 5)</sup>		
330	733701 99609	OBUS DE VÁLVULA (240-420MBAR) <sup>2) + 3) + 5)</sup>		
330	733702 99609	OBUS DE VÁLVULA (420-550MBAR) <sup>2) + 3)</sup>		
331	040200 60300	TAPA VÁLVULA <sup>2) + 3) + 5)</sup>		
332	946508 00000	TORNILLO, M6X20		
340	040100 60300	CARCASA DE FILTRO <sup>4)</sup>		
340	040101 60300	CARCASA DE FILTRO <sup>5)</sup>		
341	907505 60300	JUNTA <sup>4) + 5)</sup>		
345	907503 60300	JUNTA <sup>4) + 5)</sup>		
346	040201 60300	TAPA DE FILTRO <sup>4) + 5)</sup>		
348	907504 60300	JUNTA <sup>4) + 5)</sup>		
349	909510 30000	CARTUCHO FILTRANTE (PAPEL) <sup>4) + 5)</sup>		

<b>A</b> INDICE	Pos.	No. De pedido	Descripción	
	349	909510 30001	CARTUCHO FILTRANTE (POLIÉSTER) <sup>4) + 5)</sup>	
	350	921503 00000	EMPUÑADURA EN ESTRELLA <sup>4) + 5)</sup>	
	401	741315 00000	AMORTIGUADOR DE GOMA OPCIONAL	
	510	015100 60300	PIE	
	511	951931 00000	AMORTIGUADOR DE CAUCHO	
	619	906610 00000	COJINETE - GBB41 <sup>1)</sup>	
	626	917191 00000	ANILLO ELÁSTICO	
	651	002300 60300	FAN DEL MOTOR	
	651	002300 60400	FAN DEL MOTOR <sup>8)</sup>	
	652	948101 00000	ANILLO DE RETENCIÓN ELÁSTICO	
	652	948130 00000	ANILLO DE RETENCIÓN ELÁSTICO <sup>8)</sup>	
	653	960701 60300	CAPOT	
	653	960701 60400	CAPOT <sup>8)</sup>	
	654	K1	TORNILLO, M4X5	
	701	796302 51115	CONVERTIDOR DE FRECUENCIA <sup>7)</sup>	
	702	003602 55115	PLACA ADAPTADORA <sup>7)</sup>	
	703	025500 45000	JUNTA <sup>7)</sup>	
	704	945308 00000	TORNILLO, M5X20 <sup>7)</sup>	
	912	739200 37100	BOQUILLA OPCIONAL	
	913	951204 00000	TAPÓN ROSCADO OPCIONAL	
	914	909573 00000	AMORTIGUADOR DE CAUCHO OPCIONAL	

<sup>1)</sup> Los rodamientos estan rellenos de grasa especial. Sólo reemplazar por grasa original de Gebrüder Becker  
<sup>2)</sup> sólo para las versiones con válvula de alivio de presión DS, <sup>3)</sup> sólo para las versiones con válvula de alivio de vacío VS  
<sup>4)</sup> sólo para las versiones con filtro de aspiración F, <sup>5)</sup> sólo para las versiones con filtro de aspiración y válvula de alivio de vacío VSF  
<sup>6)</sup> con protección contra la corrosion, <sup>7)</sup> sólo para las versiones con de frecuencia, <sup>8)</sup> sólo para las versiones con motor 4,0/4,8 kW  
<sup>9)</sup> **K1** - 966900 60500 → **Pos.:** 218, 219, 223, 324, 654